

Selection of Arms, Electrodes and Accessories

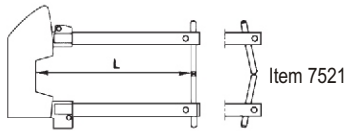

L=125 mm Item 7501
 L=250 mm Item 7502
 L=350 mm Item 7503
 L=500 mm Item 7504

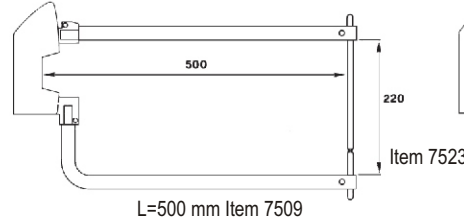

L=500 mm Item 7509

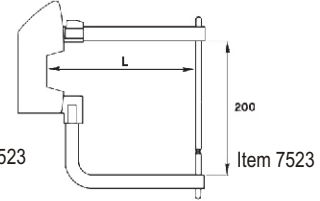

L=125 mm Item 7511
 L=250 mm Item 7506

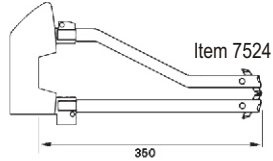

L=350 mm Item 7507

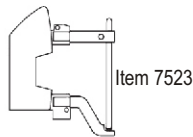

Item 7516

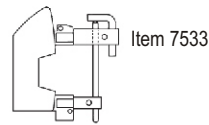

Item 7510

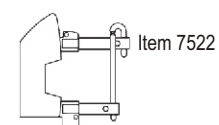

Item 7522



Item 7526

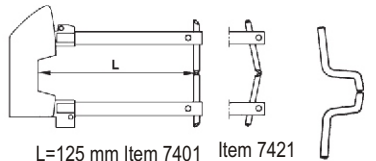

L=125 mm Item 7401
 L=250 mm Item 7402
 L=350 mm Item 7403
 L=500 mm Item 7404

Item 7421



Item 7452

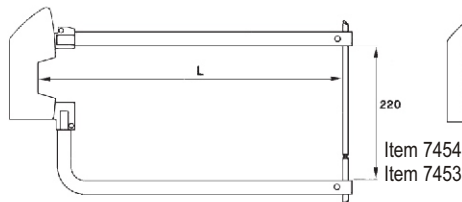

L=350 mm Item 7406
 L=500 mm Item 7407

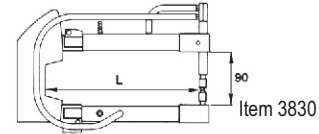

L=150 mm Item 7512
 L=250 mm Item 7513
 L=350 mm Item 7514
 L=500 mm Item 7515

Item 7454
 Item 7453

Item 3830

Arms and electrodes for item 7042

Arms and electrodes for item 7034 - suitable to all other models too



Item 5211/2



Item 5212/2



Item 5214/2



Item 3833



Item 3835

Item 9356+9357

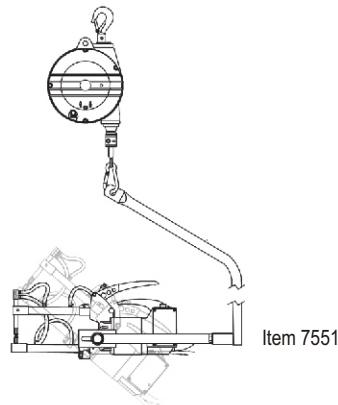

Item 7551